

《User Manual》



H501A

PLEASE READ THE MANUAL CAREFULLY BEFORE USE.

1. Quad + Phone/Pad

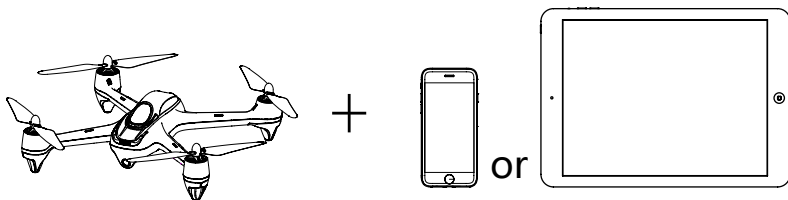

2. Quad + Phone +Relay

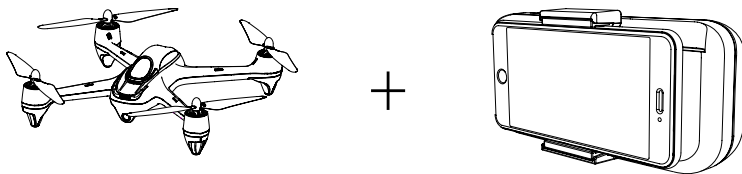

3. Quad + Transmitter

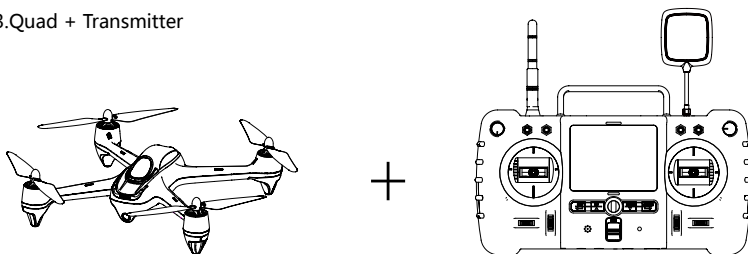



Caution:

For safety, the quadcopter is default set to CAN NOT FLY WHEN NO GPS. If you prefer to fly when GPS is not available, please reset the value as instructed below before using. Pull the throttle stick to the lowest position and press the Elevator stick for 1.5 seconds to enter into the MAIN MENU interface. Push the Elevator stick up/down to select "Fly When no GPS", push the stick right to enter into the "Fly When no GPS" interface, select "YES". The Default Setting is "NO". Select "Exit" to exit.

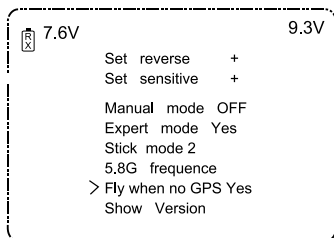
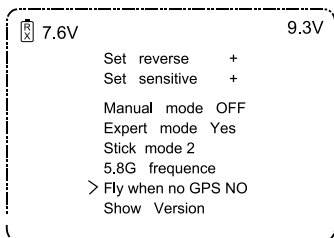

Compass calibration is required after the binding as instructed on the transmitter.

- 1) Horizontally rotate the X4 in a clockwise direction when the LCD screen shows "Calib compass 1"
- 2) Put the X4 nose down and vertically rotate it in a clockwise direction when the LCD screen shows "Calib compass 2"
- 3) Calibration is completed when the 4 LED indicators remain solid.

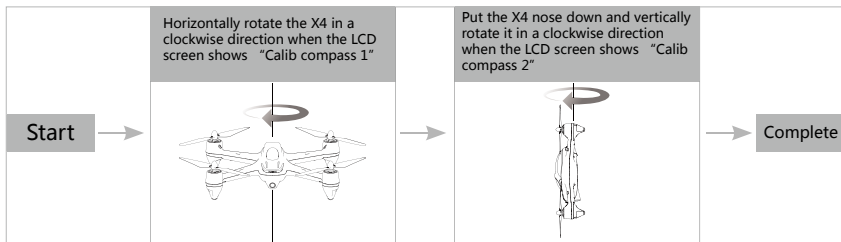

Important safety notes

Operation: Be extremely careful and responsible when using the quad. Small electronic components can be damaged due to crashes or exposure to water. To avoid any injuries, do not use the quad with broken or damaged components.

Maintenance: Do not try to fix the quad yourself, please contact authorized distributors for service. For more information, please visit the official website at www.hubsan.com.

Battery: Do not store the battery in high temperature area (60 °C or higher).

Using a Hubsan dedicated charger for recharging.



Keep the batteries away from children.

Keep the batteries dry.

- Do not fly the quad in a crowded area, always be aware of the safety of yourself and others.
- Do not fly in bad weather condition.
- Do not try to catch the quadcopter while it is still in flight.
- This product is intended for experienced pilots over the age of 14.
- Remove the battery when it is not in use, to avoid accidental injuries.
- Keep your body away from the propellers after powered on. High speed propellers are very dangerous.

Read the Disclaimer first before use.

※Symbol explanation

-  No operating  Important Notice  Instruction  Explanation, reference

USAGE ADVICE

Hubsan provides you with two files for your quad:

1. 《Disclaimer》
2. 《Quick Start Guide》

Watch the tutorial video and read the Disclaimer first.

For detail information, please download User Manual at www.hubsan.com.

Safety Advisory Notice for Lithium-Polymer (LIPO) Batteries LiPo batteries are different from conventional batteries in that their chemical contents are encased in a relatively lightweight foil packaging. This has the advantage of significantly reducing their weight but it does make them more susceptible to damage if roughly or inappropriately handled. As with all batteries, there is a risk of fire or explosion if safety practices are ignored:

- If you do not plan to fly the quad for a long time, store the battery approximately 50% charged to maintain battery performance and battery life.
- Please use Hubsan chargers for battery charging.
- Discharging the battery within 5C current , do not over-discharging.
- Do not charge on carpet to avoid fire.
- Batteried need to be recharged if not in use for over 3 months.

1. Charge and store LiPo batteries in a location where a battery fire or explosion (including smoke hazard) will not endanger life or property.
2. Keep LiPo batteries away from children and animals.
3. Never charge the LiPo battery that has ballooned or swelled.
4. Never charge the LiPo battery that has been punctured or damaged.
5. After a crash, inspect the battery pack for signs of damage. Discard in accordance with your country' s recycling laws.
6. Never charge the LiPo battery in a moving vehicle.
7. Never overcharge the LiPo battery.
8. Never leave the LiPo battery unattended during recharging
9. Do not charge LiPo batteries near flammable materials or liquids.
10. Ensure that charging leads are connected correctly. Reverse polarity charging can lead to battery damage or a fire or explosion.
11. Have a suitable fire extinguisher (electrical type) OR a large bucket of dry sand near the charging area . Do not try to extinguish electrical (LiPo) battery fires with water.
12. Reduce risks from fire/explosion by storing and charging LiPo batteries inside a suitable container.
13. Protect your LiPo battery from accidental damage during storage and transportation. (Do not put battery packs in pockets or bags where they can short circuit or can come into contact with sharp or metallic objects.).
14. If your LiPo battery is subjected to a shock (such as a crash), place it in a metal container and observe for signs of swelling or heating for at least 30 minutes.
15. Do not attempt to disassemble or modify or repair the LiPo battery.

Contents









IMPORTANT SAFETY NOTES	1	7.3.2 COMPASS CALIBRATION	13
SYMBOL EXPLANATION	1	7.4 FLY WITH TRANSMITTER	13
USAGE ADVICE	1	7.4.1 BIND THE QUAD WITH TRANSMITTER	13
INTRODUCTION	4	7.4.2 COMPASS CALIBRATION	13
1.ITEMS INCLUDED IN THE BOX	4	7.4.3 HORIZONTAL CALIBRATION	14
2QUAD COPTER	5	7.4.4 ROTATION CALIBRATION	15
2.1QUAD COPTER MOTOR LED INDICATOR	5	7.4.5 START/ STOP THE MOTORS	15
3QUAD COPTER BATTERY	5	7.4.6 BASIC FLIGHT	15
3.1INTRODUCTION	5	8 ADVANCED PERFORMANCE SETUP	17
3.2INSTALL THE BATTERY	5	8.1 REVERSING CHANNEL SETUP	17
3.3CHARGING	6	8.2 SENSITIVITY SET UP	17
4PROPELLERS	6	8.3 HEADLESS MODE	18
4.1INTRODUCTION	6	8.4 FOLLOW ME MODE	18
4.2 INSTALLING THE PROPELLERS	6	8.5 HOME MODE	19
4.3 REMOVING THE PROPELLERS	7	8.6 EXIT HOME MODE	19
5 X-Hubsan App	7	9 FAILSAFE MODE	20
6 TRANSMITTER	7	H501A TROUBLESHOOTING	20
6.1 INTRODUCTION	7	SCHEMATIC DIAGRAM	22
6.1.1 TRANSMITTER KEY FUNCTION	8	H501A Spare Part Chart	23
6.1.2 INSTALL THE TRANSMITTER BATTERY	10		
6.1.3 TRANSMITTER STICK CALIBRATION	10		
6.1.4 ADJUSTABLE 5.8GHZ FREQUENCY	11		
6.1.5 ANTENNA INSTRUCTION	12		
7 START TO FLY	12		
7.1 FLIGHT ENVIRONMENT	12		
7.2 SAFETY CHECK BEFORE FLIGHT	12		
7.3 FLY WITH APP	13		
7.3.1 CONNECT THE QUADCOPTER WITH APP	13		

Introduction

Thank you for buying the HUBSAN product. It is designed as an easy-to-use, multi-functional RC model, capable of hovering and acrobatic flight maneuvers. Please read the manual carefully and follow all the instructions. Be sure to keep the manual for future reference.

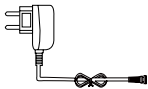
 FPV : FFirst Person View , this feature enables you to experience every live moment of the flight from the drone's point of view.

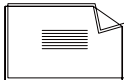
1. Items included in the box

S/N	Part Name	Photos	Qty	Remarks
1	Quad copter		1PC	Equipped with GPS and compass
2	Propellers		2Sets	Propeller A 4pcs, Propeller B 4pcs
3	Li-Po battery		1PC	For quad copter
4	Balance Charger		1PC	For recharging the LiPo battery
5	Adapter		1PC	110v-220v
6	Propeller Wrench		1PC	For removing propellers
7	User Manual		2PCS	《Disclaimer》 《Quick Start Guide》
8	Relay HT005		1PC	Use with X-Hubsan APP

2. Quadcopter

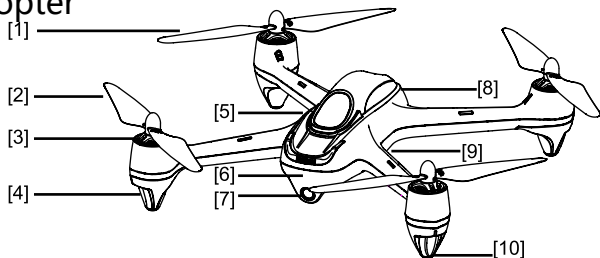

- [1] Propeller B [2] Propeller A [3] Motor [4] LED Light [5] Upper Body Shell
 [6] Lower Body Shell [7] 1080P Camera [8] Battery Compartment [9] TF Slot
 [10] Rubber Feet

2.1 Quadcopter motor LED indicator

Front LED is blue; Back LED is red.

1. Power on: 4 LED indicators blink simultaneously.

2. Compass Calibration:

1). Horizontal calibration: 4 LED indicators blink circularly.

2). Vertical calibration: 4 LED indicators blink alternately .

3. Quadcopter Horizontal Calibration: 4 LED indicators blink slowly.

4. Quadcopter Rotation Calibration: 4 LED indicators blink circularly.

5. GPS Flight: 4 LED indicators will remain solid.

6. Low Voltage Return : 2 front LED indicators remain solid, and 2 back LED indicators blink quickly.

7. Signal Lost: 2 front LED indicators blink alternately, 2 back LED indicators remain solid.

8. LED indicators can be turned off by long pressing the lower throttle trim on the transmitter.

3 Quadcopter battery

3.1 Introduction

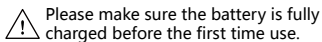

Please make sure the battery is fully charged before the first time use.

The quadcopter battery is a rechargeable Li-Po battery with 2700mAh capacity and 7.4V voltage. The battery should only be charged with Hubsan charger to avoid overcharge.

3.2 Installing the battery

Push the battery into the battery compartment (as shown below) and connect the battery cable with the correct polarity then close the battery compartment cover.

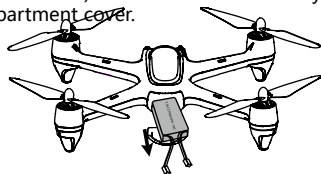



3.3 Charging

Connect the battery to the balance charger and the wall charger. The left LED indicator on the balance charger will remain red and the right LED indicator will remain off when charging. The battery is fully charged when the right LED indicator turns green.

It takes approximately 180 minutes to fully charge the battery.

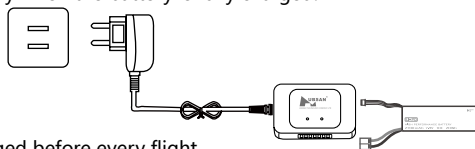
Please take off the charger and the battery when the battery is fully charged.



 Make sure the battery is fully charged before every flight.



4 Propellers

4.1 Introduction

The quadcopter uses 7.3 inches propellers which are marked by A and B.

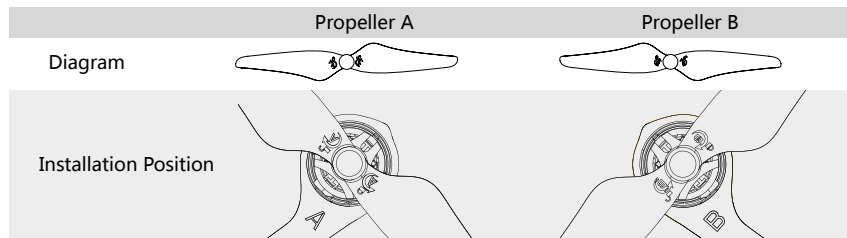
Propellers are consumables, please replace with new ones if there is any damage.



Symbol explanation  LOCK: In this direction, tighten the propeller onto the motor shaft
 UNLOCK: In this direction, remove the propeller from the motor shaft

4.2 Installing the propellers

Install the propellers to the corresponding motors that are marked with A and B, tighten the propellers and keep the motors deadlocked with the U wrench.

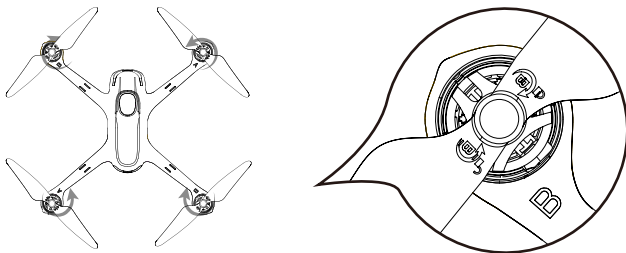

4.3 Removing the propellers

Hold the motor with the wrench, then spin the propellers in the indicated unlock direction.

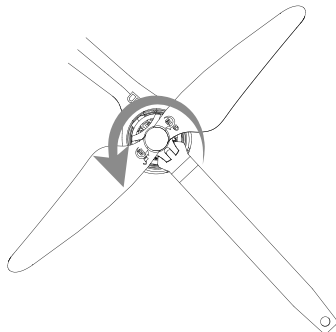

- Make sure that the A and B propellers are installed correctly. The X4 will not fly if propellers are improperly installed.
- Keep the moving propellers away from your body as well as other people and any obstacles.

5 X-Hubsan App

Hubsan designed an APP to go with the new X-Hubsan H501A. Users can use the APP to control the quad, take picture/videos and set the parameters of the quad. It is recommended to fly the quad within 100 meters and use smart devices with larger screen for the best visual experience.

6 Transmitter

6.1 Introduction

Hubsan H901A is a multi-functional FPV transmitter with 3.7inch LCD screen and 5.8G live stream.

Recommended maximum flight distance: 300m.

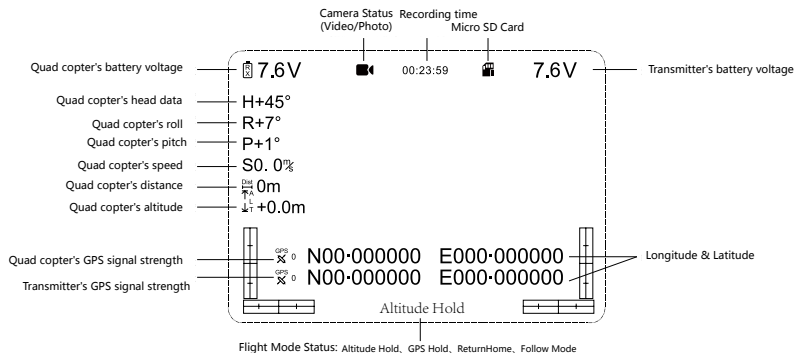

6.1.1 Transmitter key function

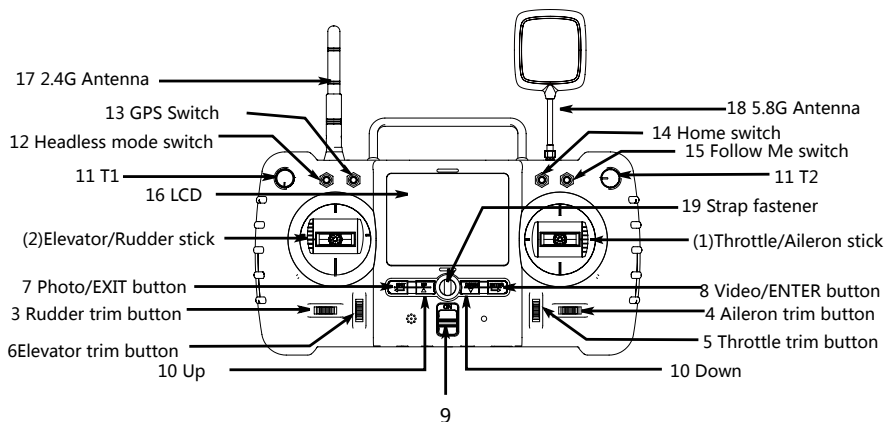

MODE 1

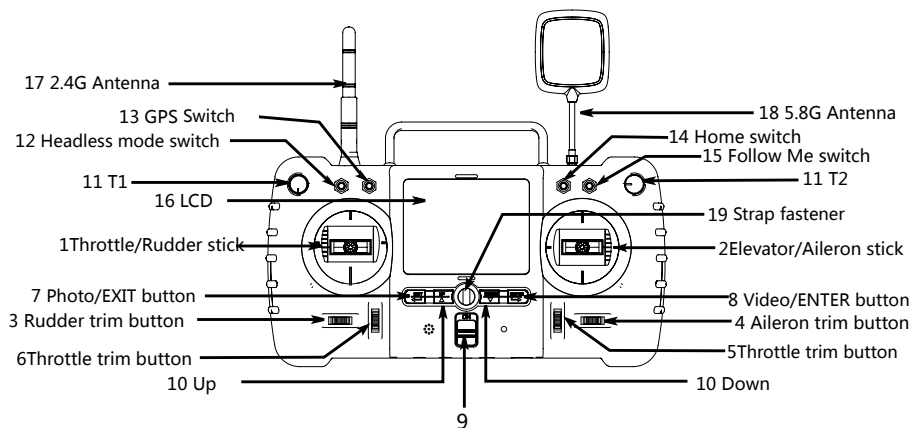

MODE 2

S/N	Mode/ Control	Function
1	Throttle/Rudder stick	Push the stick forward or backward and the quadcopter will ascend or descend; Push the stick left or right and the quadcopter will rotate in counter clockwise or in clockwise
2	Elevator/Aileron stick	Push the stick forward or backward and the quadcopter will fly forward or backward; Push the stick left or right and the quadcopter will fly left or right
(1)	Throttle/Aileron stick	Push the stick forward or backward and the quadcopter will ascend or descend; Push the stick left or right and the quadcopter will fly left or right.
(2)	Elevator/Rudder stick	Push the stick forward or backward and the quadcopter will fly forward or backward; Push the stick left or right and the quadcopter will rotate in counter clockwise or in clockwise.
3	Rudder trim button	Rudder trim adjusts for drift of left and right rotation or yaw.
4	Aileron trim button	Aileron trim adjusts for left and right drift.
5	Throttle trim button	Throttle trim is normally at the center.
6	Elevator trim button	Elevator trim adjusts for forward and backward drift.
7	Photo/EXIT button	Long press to exit Main Menu Short press to take photo
8	Video/ENTER button	Long press to enter Main Menu Short press to take video
9	Power Switch	Push to ON to turn on the transmitter. Push to OFF to turn off.
10	Up/Down	To select settings.
11	T1、 T2	No Function
12	Headless mode switch	Push up to enter headless mode; Push down to exit headless mode.
13	GPS Switch	Push up to activate GPS function; Push down to disactivate GPS function.
14	Home Switch	Push up to turn on automatic return home; Push down to exit.
15	Follow Me Switch	Push the switch up, the follow me function will be activated

16	LCD	Display flight data and live stream
17	2.4G Antenna	Transmit control signals
18	5.8G Antenna	Receive the video transmission
19	Strap fastener	To fasten the strap on transmitter

6.1.2 Install the transmitter battery

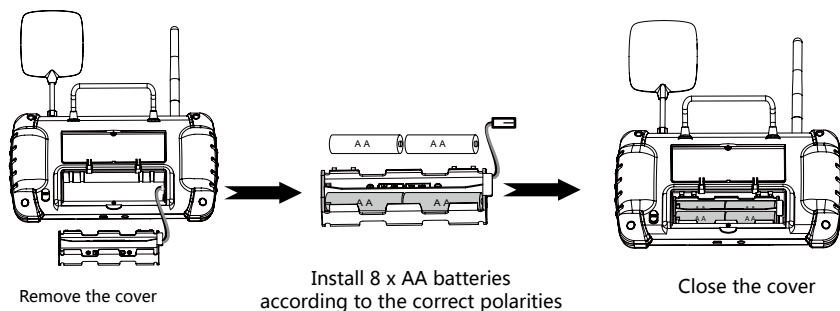

Do not mix old and new batteries

Do not mix different types of batteries

6.1.3 Transmitter stick calibration

Mode 1: Push the left stick to the upper left corner and the right stick to the upper right corner then power on the transmitter simultaneously, Rotate both sticks in circles for three times when the LCD screen displays "Calibrate Stick" then release both sticks and press "Exit" until one beep sound is made, indicating a successful calibration.

Mode 2: Push both sticks to the upper left corner then power on the transmitter simultaneously. Rotate both sticks in circles for three times when the LCD screen displays "Calibrate Stick" then release both sticks and press "Exit" until one beep sound is made, indicating a successful calibration.

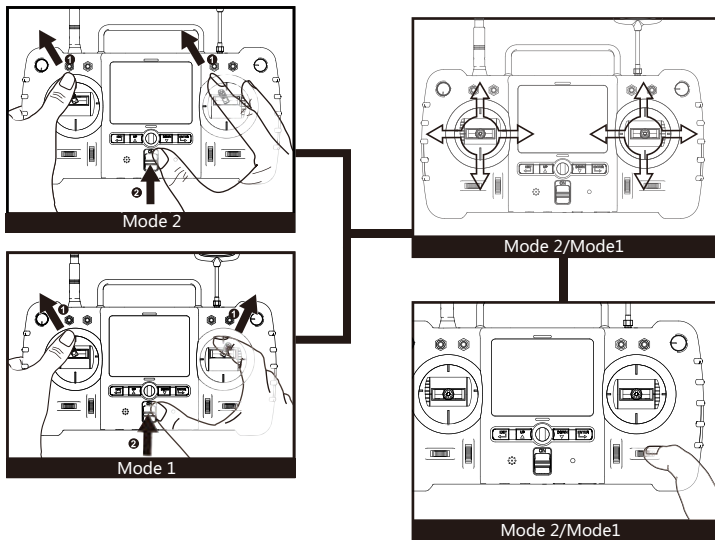

 The transmitter mode can be shifted according to the above operation.

6.1.4 Adjustable 5.8GHz frequency

The transmitter will automatically find the best frequency to ensure a good quality live video. When necessary, adjust the 5.8GHz frequency for a better video transmission.

To adjust 5.8GHz frequency:

Pull the throttle stick down to the lowest position and long press the 'Enter' button to open the 'Main Menu' interface. Use the Up/Down keys to select 5.8G frequency then press 'Enter' and switch between different frequency with Up and Down keys. Long press the 'Exit' button to save the new setting and exit.

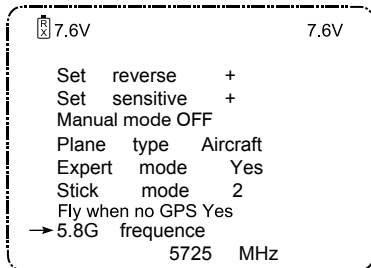
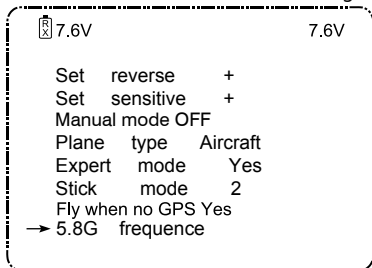



6.1.5 Antenna instruction

For maximum communication range, the 2.4G antenna should point skyward without obstructions in between; the 5.8G antenna should be bent vertically and have the side with 'Hubsan' logo pointing at the quadcopter. The maximum range of the video transmission is approximately 300 meters.

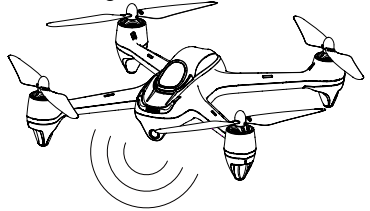
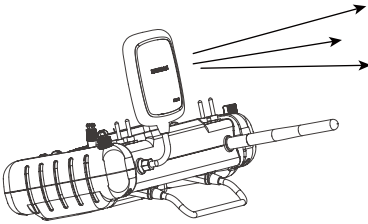

7 Start to fly

In case of any injuries caused by improper operations, it is recommended that beginners learn to operate the quadcopter under the guidance of an experienced user. It is also very important to choose a proper flight environment.

7.1 Flight environment

- (1) The flying area should be wide open and should be without any tall buildings, otherwise the GPS may not work.
- (2) Do not fly in bad weather condition such as windy, snowy, rainy or foggy weathers.
- (3) Avoid flying near obstacles, crowds, power cables, trees and water.
- (4) Do not fly near any radio towers or airports.
- (5) The quad will not work in the Antarctic Circle or the Arctic Circle.
- (6) Obey the local laws and regulations, do not fly in restricted areas.
- (7) Only fly in good weather conditions and between the temperature of 0-40°C .



High Tension Line



Airport

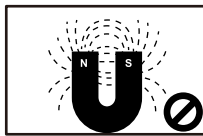

Interference



Bad Weather

7.2 Safety check before flight

- (1) Make sure the batteries are fully charged. (Quad, transmitter or smart device)
- (2) Make sure propellers are installed properly.
- (3) Insert Micro-SD card for pictures and videos.
- (4) Check if motors work well after binding.

7.3 Fly with App

APP flight is only available when fly in outdoors.

7.3.1 Connect the Quadcopter with App

- 1.Power on the quad;
- 2.Search for WI-FI on devices:
For iPhone or iPad, please select 【 Settings 】 >Wi-Fi;
For Android system,please select 【 Settings 】 >WLAN> W-Fi.
- 3.Click HUBSAN_H501A_XXXXXX,and password is 12345678.The password cannot be changed by user.
- 4.Connection completed
- 5.Open X-Hubsan APP, choose Hubsan H501A to enter into the user interface for flight.

NOTICE :

For safety,please don't use the smart device for other purposes while it is connecting with Hubsan App.
If you want to control the quad with other devices, please restart the quad.

7.3.2 Compass Calibration

Compass calibration is required before the first flight, otherwise the compass may not work properly. The compass is very sensitive to the electromagnetic interference which can create false compass data and lead to poor flight performance or even flight failure. Calibrate the compass regularly can help to provide the optimal performance of the quad.

7.4 Fly with transmitter

7.4.1 Bind the quad with transmitter

The binding process is completed in the factory.

For re-binding, press Enter button and power on the transmitter simultaneously until “Bind to Plane” is displayed, then power on the drone and place it very close to the transmitter, the binding process will be completed after one “beep” sound.

If the binding failed, please power off the drone and repeat the above steps.

7.4.2 Compass calibration

Compass calibration is required before the first flight, otherwise the compass may not work properly. The compass is very sensitive to the electromagnetic interference which can create false compass data and lead to poor flight performance or even flight failure. Calibrate the compass regularly can help to provide the optimal performance of the quad.

- ⊗ • Do not calibrate the compass in a strong magnetic field
- Do not carry ferromagnetic materials with you while calibrating the compass, such as keys, cell phones, etc.

Compass calibration procedures:

- 1) Pull the left stick to the left side, and move the right stick from left to right quickly and repeat until the transmitter displays “Calib compass1” , and the 4 LED indicators blink circularly.
- 2) Horizontally rotate the X4 in a clockwise direction until the LCD screen shows “Calib compass 2” , and the 4 LED indicators blink alternately.
- 3) Put the X4 nose down and vertically rotate it in a clockwise direction until the “Calib compass 2” disappears.
- 4) Calibration is completed when the 4 LED indicators remain solid.

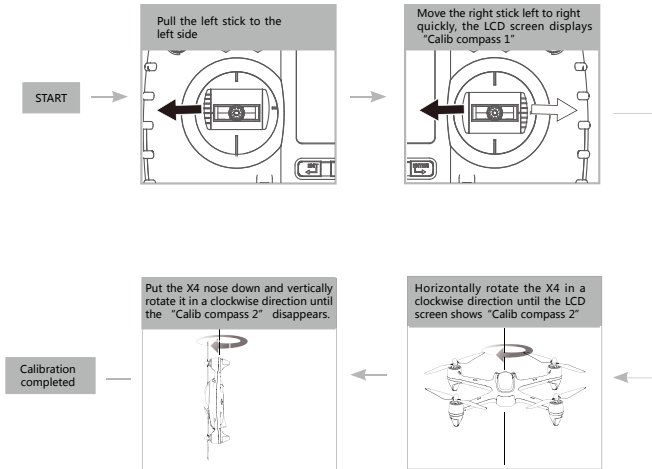

7.4.3 Horizontal calibration

Horizontal calibration is required when the quadcopter drifts during flight.

Please follow the calibrating procedures:

- 1) Push the left stick to the most right side, and move the right stick from left to right quickly until the 4 LED indicators blink slowly
- 2) Calibration is completed when the 4 LED indicators stop blinking.

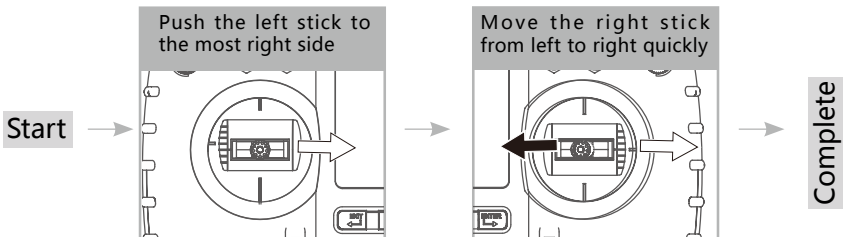

7.4.4 Rotation calibration

Rotation calibration is required when the quadcopter yaw during flight.

Please follow the calibrating procedures:

- 1) Push the left stick up, and move the right stick from left to right quickly until the 4 LED indicators blink slowly ;
- 2) When the 4 LED indicators blink circularly, horizontally rotate the X4 in a clockwise direction until the 4 LED indicators remain solid temporarily;
- 3) The 4 LED indicators will blink circularly again, repeat step 2 to rotate the X4;
- 4) Calibration is completed when the 4 LED indicators stop blinking.

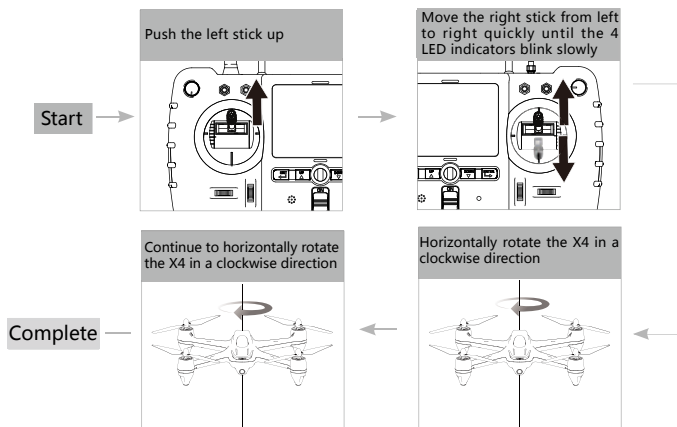

7.4.5 Start/stop the motors

Pull both sticks to the lower outer corner as shown on the picture to start or stop the motors.
Push the throttle stick up slowly to take off;
Push the throttle stick down slowly to land.

Caution:

Keep the moving propellers away from your body as well as other people and any obstacles.

Do not let go of the controller until the motors have fully stopped.

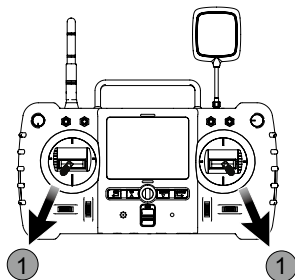

Do not stop the motors during the flight to avoid crashing, unless for emergency.



7.4.6 Basic flight

The operations of the controller are based on Mode 2.

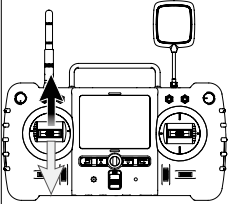
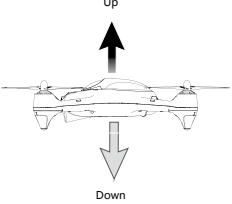
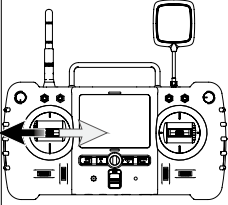
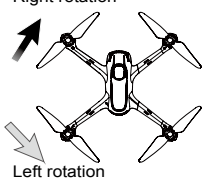
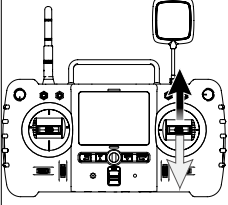
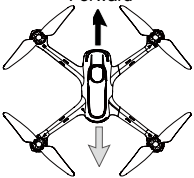
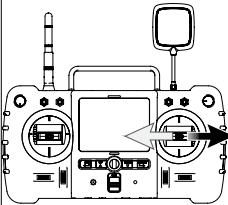
The left stick controls the altitude and rudder of quadcopter, and the right stick controls its forward, backward, left and right flight.

Transmitter (Mode 2)	X4	Remarks
	<p style="text-align: center;">Up</p>  <p style="text-align: center;">Down</p>	<p>The throttle stick controls the ascent and descent . Push up the stick and the X4 will ascend. Pull down the stick and the X4 will descend. When the stick is in the center, the X4 will hover and hold its altitude automatically . Move the throttle stick above the center position to take off. (Move the stick gradually to prevent the X4 from ascending too quickly.)</p>
	<p style="text-align: center;">Right rotation</p>  <p style="text-align: center;">Left rotation</p>	<p>The Rudder stick controls the direction. Push the stick left and the X4 will rotate counter-clockwise Push the stick right and the X4 will rotate clockwise When the stick is in center,the X4 rotation angle is zero and doesn't rotate. A harder push in either direction will cause the X4 to rotate faster in the corresponding direction.</p>
	<p style="text-align: center;">Forward</p>  <p style="text-align: center;">Backward</p>	<p>The Elevator stick moves the X4 forward and backward. Push the stick up the and the X4 will fly forward; Pull the stick down and the X4 will backward. When the stick is in center, the aircraft will hold its position. The degree of stick movement corresponds to the degree of tilt and flying speed.</p>
	 <p style="text-align: center;">Left</p> <p style="text-align: center;">Right</p>	<p>The Aileron stick controls left and right flight. Push the stick left and the X4 will fly left Push the stick right and the X4 will fly right The X4 should be horizontal and unmoving at center stick. The flight speed and tilt angle are linked to the distance pressed on the sticks.</p>

Transmitter (Mode 2)	X4	Remarks
		<p>The GPS Switch is position-hold function switch.</p> <p>In position 1 (up), the GPS functions are active.</p> <p>In position 2 (down), the GPS functions are deactivated.</p> <hr/> <p>The Home Switch is used to the turn on/off automatic return function.</p> <p>Up (Position 1) activates the Home function.</p> <p>Down (Position 2) deactivates the Home function.</p>

8 Advanced performance setup

8.1 Reversing channel setup

If you would like to reverse any of the stick functions due to personal preference, then follow the instructions below. Be aware that this will reverse the control commands.

Pull the throttle stick down to the lowest position and long press the 'Enter' button to open the 'Main Menu' interface. Use the Up/Down keys to select 'Set reverse' and use 'Enter' button to switch between modes. Long press 'Exit' button to save and exit.

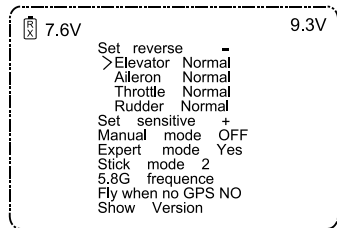
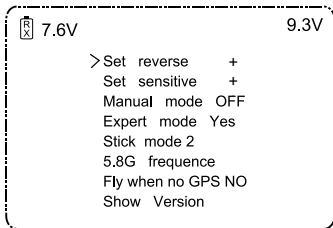

8.2 Sensitivity setup

If you would like to adjust the sensitivity of any stick functions, then follow the instructions below.

Pull the throttle stick down to the lowest position and long press the 'Enter' button to open the 'Main Menu' interface. Use the Up/Down keys to select 'Set sensitive' and use 'Enter' button to switch between 'Expert mode' and 'Normal Mode'. Long press 'Exit' button to save and exit.

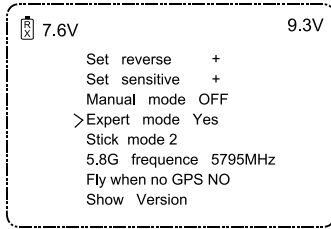

8.3 Headless mode

Headless mode means the X4 will default the current head direction as its head when enter into the headless mode.

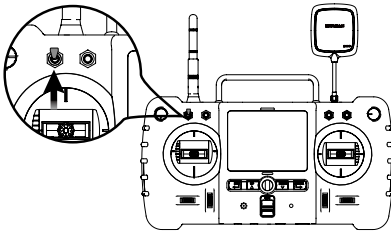

Push the A switch up to enter Headless mode and push the A switch down to cancel Headless mode.

The Head data displays in red when the quad copter enters into headless mode.
The Head data displays in green when the quad copter exits headless mode.

8.4 Follow me mode

 The transmitter has a built-in GPS module. The Follow Me mode only works when both the quadcopter and the transmitter have 6 or more GPS satellites.

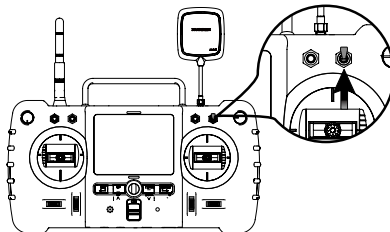

Push the B switch up to enter Follow Me mode and push the B switch down to cancel Follow Me mode.

When the switch is pushed up, the screen will display 'Follow Mode' in green and the quadcopter will turn and have the camera pointing at the transmitter. Only the throttle stick will still function under Follow Me mode.

8.5 Home mode

 The Return to Home mode will only work when both the quadcopter and the transmitter have 6 or more satellites.

Enter into home mode

Push both the GPS switch and Home switch up to activate Return to Home mode on the quadcopter.

The flight control system will control the quadcopter to fly back to the takeoff point and land automatically.

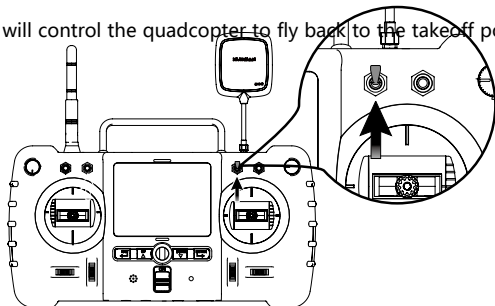

8.6 Exit home mode

 The home point is the location where the quadcopter receives the 6th satellite while the motors are armed.

Push the Home switch down to exit return to home mode.

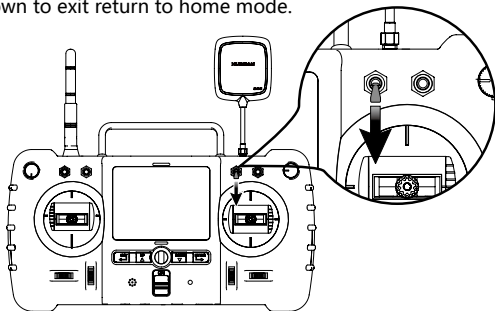



9 Failsafe mode

The quadcopter will enter Failsafe mode when the connection between the transmitter is lost or when the power is low. The flight control system will control the quadcopter to return to the Home Point and land automatically. The Failsafe mode helps to avoid injuries or damages.

Conditions that will activate Failsafe mode

- (1) Transmitter is powered off.
- (2) The flight distance is over the signal transmission range of the transmitter.
- (3) The signal of the transmitter was interrupted by some other strong electronic interference.



Home Point is recorded when the quadcopter receives the 6th satellite while the motors are armed.

- To ensure that the X4 can return safely to its Home Point, fly the X4 in a safe to fly area.
- If there are GPS satellites drops below 6 or less for more than 20 seconds while the X4 is returning home, the X4 will descend automatically.
- The X4 cannot avoid obstacles automatically while in Failsafe mode.
- If the power is low, please land the quadcopter in case of any damages.

H501A TROUBLESHOOTING

1. Transmitter and X4 do not pair
 - 1) Check if the transmitter and the X4 are both power on or not.
 - 2) Re-pair by the following steps 1 Power off the transmitter.
2. Press the camera function key and power on the transmitter till "Bing to plane" displays on the LCD screen.
3. Face the X4' s bottom to the transmitter' s LCD screen very closely and power on the X4, hold 5 seconds till the pair is finished.
2. Cannot Unlock the propellers
 - 1) Make sure the X4 is finished the compass calibration.
 - 2) Make sure the Home switch is in the downward position.
 - 3) Make sure the sticks are all in the center positions.
3. Cannot Search GPS Signals

Make sure not fly indoor or fly surround by buildings.
Make sure fly in outdoor and in an open field and void of obstacles, tall building or steel structures.

4. No Video or Video is Under Strong Interference
 - 1) Check if any strong interference sources around or not
 - 2) Check if the frequencies of the X4 and the transmitter are under cross interference or not. (If so, please re-pair the X4 and the transmitter)
5. Cannot Hover

Check if the barometric parameters displayed on the transmitter are correct or not.
Check if the sticks are in the center position or not. (If not, please push the sticks to the center positions)
6. Cannot Flight In a Set-Waypoint

Make sure the GPS switch is in upper position.
Make sure the GPS satellites are up to 6 or above.
Make sure all the sticks are in the center positions, except the throttle stick.
7. Follow Mode Function Not Work

Make sure the GPS and follow mode switches are in upper positions.
Make sure the GPS satellites are up to 6 or above.
Make sure all the sticks are in the center positions, except the throttle stick.
Make sure 5 meters at least between the X4 and the transmitter.
8. Cannot fly back to Home Point!

Be sure the GPS satellites are more than 6 before flying.
9. GPS signal lost!

Check if there is any interference to quad or not, for example: high-tension cables, radio tower.
10. The quad or video shakes while flying
 - ① Check the propellers, replace propellers if there is any broken or deformed;
 - ② Check the screws on quadcopter are fixed in place or not;
 - ③ Check the motor shaft is broken or not.
11. Cannot take pictures or videos!
 - ① Check if the Micro-SD card is inserted or not.
 - ② Check if the Micro-SD card is formatted correctly or not (For format the Micro-SD card before use, if the Micro-SD card is with FAT32, the card should be Class 4 or Class 4+)
12. Cannot connect with Wi-Fi

Restart the quadcopter.
13. If you want to use the relay during flight, please unbind the quadcopter with the APP, otherwise the relay cannot be connected.



SCHEMATIC DIAGRAM

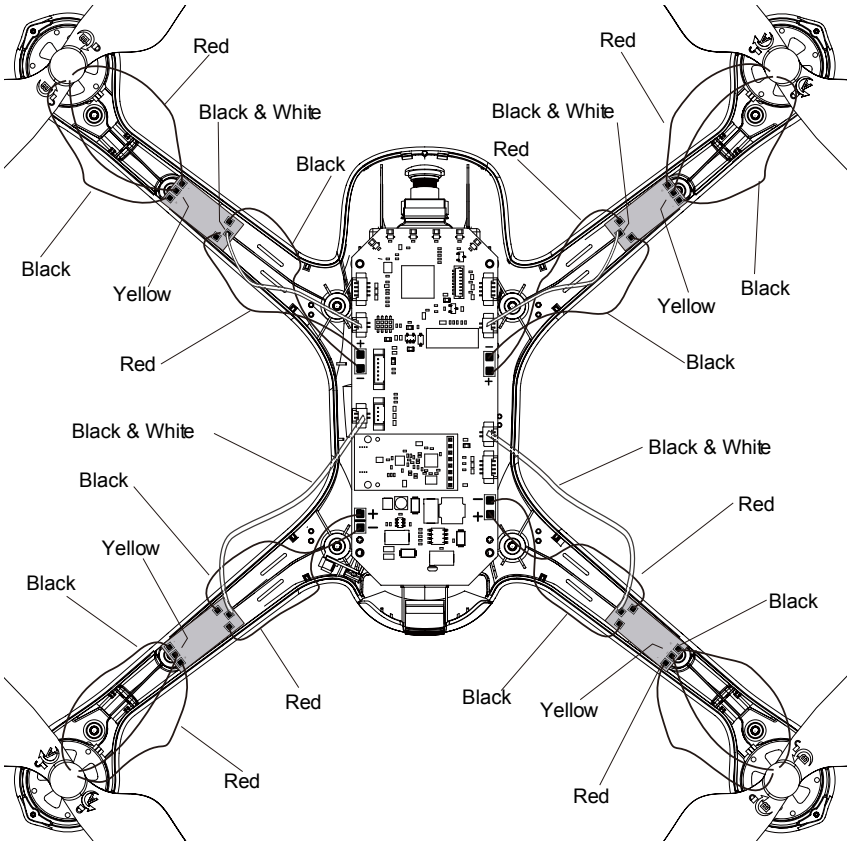

H501A Spare Part Chart



H501A-01
Body Shell- Black



H501S-01
Body Shell- White

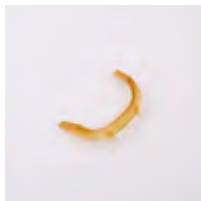

H501S-17
Eye Lampshade

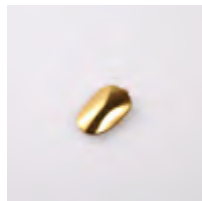

H501S-03
Canopy



H501S-18
Motor LED Lampshade
A/B

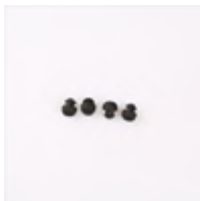

H109-04
Rubber Feet

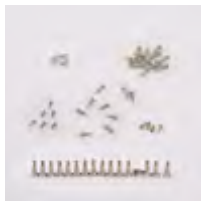

H501S-04
Screw

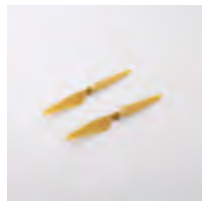

H501S-05
Propeller A- Gold



H501S-05B
Propeller A- Black

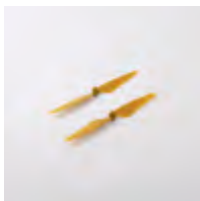

H501S-06
Propeller B- Gold



H501S-06B
Propeller B- Black

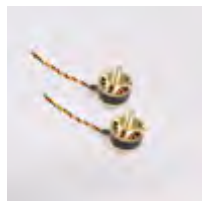

H501S-07
Brushless Motor A

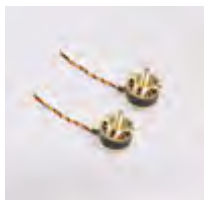

H501S-08
Brushless Motor B



H501S-19
ESC



H501C-10
LED PCBA(Blue/Red)



H501A-02
Flight Control PCBA



H501A-03
5.8G Transmission
Module



H501A-05
GPS Module



H501S-13
Compass Module



H501S-14
Li-Po Battery



H501C-02
Battery Cover



H501S-27
H906A TX



H301S-12
Balance Charger



H501S-16
Propeller Wrench



H501S-25
H901A TX Li-Po Battery



H501S-26
USB Cable



H501A-04
HT005 Relay



H301S-11
Adapter



 More Product Information